

PREXISO X2 LASER DISTANCE METER

GB Operating instruction

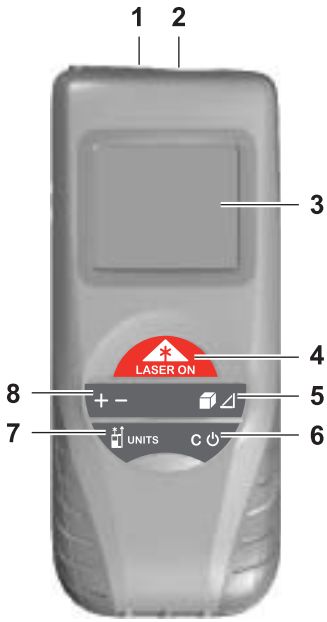
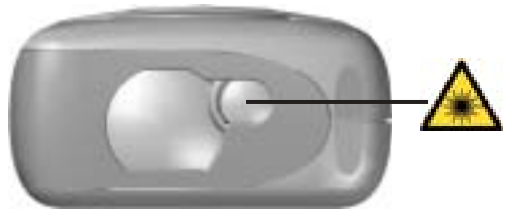
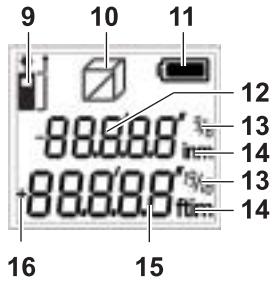
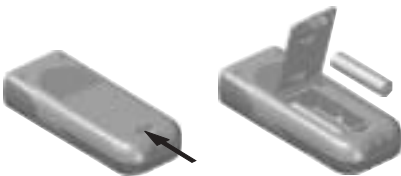
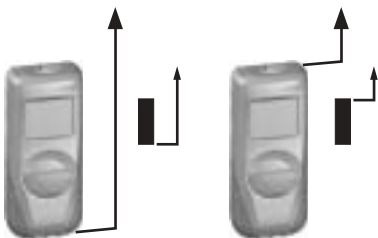

PREXISO
LASER DISTANCE METER

A**B****C****D****E****F**

1 Symbols

1.1 Warning notices

The warning notices differ from one another concerning the type of danger through the following signs:

- ➔ **Caution** warns against damage to property.
- ➔ **Warning** warns against bodily harm.
- ➔ **Danger** warns against danger to life.

Composition of the warning notices



Signal words

Type and source of the danger!

- ➔ Measure to avoid the danger.

1.2 Other symbols

Notes

Note: Notes on appropriate handling of laser measuring devices.

Operating instructions

Composition of the operating instructions:

- ➔ Guidance to an operation.

Indication of an outcome, if necessary.

Schedules

Composition of the non numbered schedules:

- ➔ Schedule level 1
 - ➔ Schedule level 2

Composition of the numbered schedules:

1. Schedule level 1
2. Schedule level 1
 - 2.1 Schedule level 2
 - 2.2 Schedule level 2

2 Safety and dangers

- ➔ Make sure that the device is not used without instructions.
- ➔ Make sure that the device is used exclusively according to the instructions.
- ➔ Make sure that the safety settings are not disabled.
- ➔ Make sure that indication labels and caution labels are not removed.
- ➔ Do not open the device with tools (screwdriver etc.).
- ➔ Make sure that the device is not converted or modified.

- ➔ Avoid using accessories of other producers that are not recommended by Prexiso.
- ➔ Make sure that the device is not used carelessly:
 - ➔ when working on scaffolds
 - ➔ when climbing ladders
 - ➔ when measuring near running machines
 - ➔ when measuring on open machine parts or installations
- ➔ Avoid aiming directly at the sun.
- ➔ Avoid blinding other persons intentionally (also in darkness).
- ➔ Make sure that the measuring position is secured sufficiently. (e.g. in streets, on construction sites, etc.)
- ➔ Make sure that the device is in proper and flawless condition.
- ➔ Do not use a defective device.

3 Correct ways of employment

- ➔ measuring of distances
- ➔ calculation of functions e.g. areas and volumes
- ➔ Use the device exclusively in an atmosphere that is permanently inhabitable by humans.

4 Foreseeable misuse

- ➔ Do not use the device as a laser pointer.
- ➔ Do not use the device in explosive or aggressive environments.

5 Areas of responsibility

5.1 Area of responsibility of the manufacturer of the original equipment

Prexiso AG, CH-8152 Glattbrugg (hereafter Prexiso):

- ➔ Prexiso is responsible for the safety-related flawless delivery of the device, including the operating instructions.
- ➔ Prexiso is not responsible for accessories produced by other manufacturers.

5.2 Area of responsibility of the operator



Caution

Damage to property due to repairing!

- In case of malfunctions, contact the dealer.

The operator is obliged to observe the following:

- ➔ He understands the protection information on the device and the operating instruction.
- ➔ He is familiar with the customary in-house accident control directives.

6 Overview

6.1 Keys

See drawing A:

1. laser emitter
2. receiver lens
3. display
4. on/measure
5. area/room volume/Pythagoras
6. clear/off
7. measuring plane/unit
8. add/subtract

6.2 Display

See drawing D:

9. measuring plane
10. area/room volume/Pythagoras
11. battery symbol
12. second row
13. fractions/exponents
14. units
15. summary row
16. addition/subtraction

7 Initial operation

Insert the batteries

See drawing E:

- To ensure a reliable use, use exclusively alkaline batteries.
- Remove battery compartment cover.
- Insert alkaline batteries (2 x AAA) pay attention to the correct polarity.
- Close the battery compartment cover.

Changing the batteries

- Change the batteries when the battery symbol is flashing permanently.

8 How to use

8.1 Measuring conditions

The quality of the measurement depends on the surfaces to which you are measuring.

Measurement errors



Caution

Damage to property due to use of wrong measuring results!

- Avoid measuring errors due to unexpected events during distance measuring.
- Perform a control measurement.

Measuring errors are possible in case of:

- ➔ colourless fluids (e.g. water)
- ➔ clean, translucent glass
- ➔ styrofoam or similar semi-translucent surfaces
- ➔ strongly reflecting targets that deflect the laserbeam
- ➔ measurements aimed at moving objects

Causes:

- ➔ Strongly reflecting targets deflect the laser beam and cause measuring errors.
- ➔ Non-reflecting, dark surfaces increase the measuring time.

For constantly high-quality measurements

- Perform control measurements periodically.
- Perform control measurements before and after important measurements.

8.2 Switching on/off

- Switch on the device by pressing key **4** briefly.

The device shows the battery symbol until another key is pressed.

- Switch off the device by holding key **6** for several seconds.

If no key is pressed for 180 seconds, the device switches off automatically.

8.3 Clear key

- Undo the most recent action by pressing key **6** briefly.

8.4 Adjusting the measuring plane

See drawing **F - H**:

Rear measuring plane is the standard setting.

- For measurement from front edge, press key **7** briefly.
- For measurement from rear edge, press key **7** briefly again.

8.5 Unit setting

Metric system is the standard setting.

- To change the unit, hold key **7** for several seconds.

With every keypress, the device switches to the next unit.

Possible units:

- ➔ meters with mm display
- ➔ feet inch fractional
 - ➔ summary row up to 1/16 inch
 - ➔ second row up to 1/8 inch
- ➔ inch fractional
 - ➔ summary row up to 1/16 inch
 - ➔ second row up to 1/8 inch

9 Measuring

9.1 Measuring single distances

- Press key **4** briefly.
- Aim active laser at target area.
- Press key **4** briefly.
The device measures the distance.

The device displays the result immediately.

9.2 Continuous measuring

See drawing **J**:

This function enables distances to be staked out.

- Hold key **4** for several seconds.
Continuous measuring starts.
- Press key **4** briefly.
Continuous measuring stops.

The value last measured appears in the summary row.

10 Functions

10.1 Add/Subtract

Add:

- Measure the first distance.
- Press key **8** once.
The device adds the second measuring result to the first measuring result.
- Measure the second distance.

Subtract:

- Measure the first distance.
- Press key **8** twice.
The device subtracts the second measurement result from the first measurement result.
- Measure the second distance.

Repeat if required. The device displays the result in the summary row and the previous value in the second row.

10.2 Area

See drawing **I**:

- Press key **5** once.
The area symbol appears on the display.
- Press key **4** and measure the first distance.
(e.g. length).
- Press key **4** and measure the second distance.
(e.g. width).

The device displays the result in the summary row and the respective measured distance to the next measurement in the second row.

10.3 Room volume

- Press key **5** twice.
The volume symbol appears on the display.
- Press key **4** and measure the first distance
(e.g. length).
- Press key **4** and measure the second distance
(e.g. width).
- Press key **4** and measure the third distance
(e.g. height).

The device displays the result in the summary row and the respective measured distance to the next measurement in the second row.

10.4 Pythagoras

See drawing **K**:

- Press key **5** three times.
The Pythagoras symbol appears on the display.
- Press key **4** and measure the first distance
(diagonal measurement).

- Press key **4** and measure the second distance (horizontal measurement).

The device displays the result in the summary row and the respective measured distance to the next measurement in the second row.

11 Troubleshooting

- If the message **Error** does not disappear after switching on the device repeatedly, please contact the dealer.
- If the message **InFo** appears with a number, observe the instructions in the following table.

No.	Cause	Correction
204	Calculation error	Perform measurement again.
252	Temperature too high	Let the device cool down.
253	Temperature too low	Warm the device up.
255	Reception signal too weak, measuring time too long	Change target surface (e.g. white paper).
256	Input signal too high	Change target surface (e.g. white paper).
257	Measuring error, too much background light	Shadow the target area.
258	Measurement outside of the measuring range	Mind the range.
260	Laser beam interrupted	Repeat the measurement.

12 Technical data

Range	0.1 m to 30 m 0.33 ft to 98 ft
Measuring accuracy (2 σ)	typ.: ± 2.0 mm* ± 0.08 in*
Smallest unit displayed	1 mm 0.08 in
Laser class	2
Laser type	635 nm, < 1 mW
Automatic switch-off	after 180 s
Continuous measuring	yes
Addition/Subtraction	yes

Dimension (H x D x W)	123 x 50 x 26 mm 4.84 x 1.97 x 1.02 in
Battery durability (2 x AAA)	up to 3000 measurements
Weight	100 g
Temperature range:	
- Storage	-25 °C to 70 °C -13 °F to 158 °F
- Operation	0 °C to 40 °C 32°F to 104°F

* under favourable conditions (good target surface, room temperature) up to 10 m (33 ft). Under unfavourable conditions such as bright sunlight, a very weakly reflecting target surface or large temperature fluctuations, the error can increase to ± 0.25 mm/m (± 0.003 in/ft) for distances over 10 m (33 ft).

12.1 Electromagnetic compatibility (EMC)



Warning

Possible disturbance of other devices (e.g. safety equipment, medical equipment) due to electromagnetic radiation!

- Observe the safety instructions of the respective devices.

Despite the compliance with all requirements of the corresponding directives and norms, a disturbance of other devices is possible.

12.2 FCC statement (applic. in U.S.)

This equipment has been tested and found to comply with the limits for a Class B digital device, pursuant to part 15 of the FCC Rules. These limits are designed to provide reasonable protection against harmful interference in a residential installation. This equipment generates, uses and can radiate radio frequency energy and, if not installed and used in accordance with the instructions, may cause harmful interference to radio communications. However, there is no guarantee that interference will not occur in a particular installation. If this equipment does cause harmful interference to radio or television reception, which can be determined by turning the equipment off and

on, the user is encouraged to try to correct the interference by one or more of the following measures:

- Reorient or relocate the receiving antenna.
- Increase the separation between the equipment and receiver.
- Connect the equipment into an outlet on a circuit different from that to which the receiver is connected.
- Consult the dealer or an experienced radio/TV technician for help



Warning

Changes or modifications not expressly approved by PREXISO for compliance could void the user's authority to operate the equipment. Position of the product label see first page!

Product labelling:

This device complies with part 15 of the FCC Rules.

Operation is subject to the following two conditions:

1. This device may not cause harmful interference, and
2. this device must accept any interference received, including interference that may cause undesired operation.

12.3 Laser classification

The Prexiso X2 generates a visible laser beam that is emitted on the front of the device.

The device complies with laser class 2 according to:

➔ IEC60825-1: 2007 Safety of laser products

Laser class 2 products

Do not look into the laser beam and do not unnecessarily aim at other persons. The eye is usually protected by preventive reactions such as the eyelid closure reflex.



Warning

Bodily harm due to laser beam!

- Do not look directly into the laser beam.
- Do not look directly into the laser beam with optical appliances (such as binoculars, telescopes).

Labels

Position of the type label see drawing C

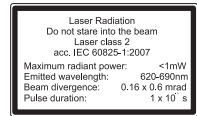

13 Care

- Clean the device with a damp, soft cloth.
- Never immerse the device in water.
- Never use aggressive cleaning agents or solvents.

14 Warranty

The Prexiso X2 has a two-year warranty.

For further information on this, contact your dealer.

Subject to change (drawings, descriptions and technical data).

15 Disposal



Caution

Damage to property due to inappropriate disposal!

- Dispose of the device and the batteries according to the national, country-specific disposal directives.
 - Protect the device and the batteries from access of unauthorised persons.
-



For disposal, observe the following:

- Do not put the appliance and the batteries into the household waste.
- Dispose of the device and the batteries appropriately.

Product-specific information on treatment and disposal can be downloaded from the Prexiso homepage <http://www.prexiso.com> or requested of your dealer.

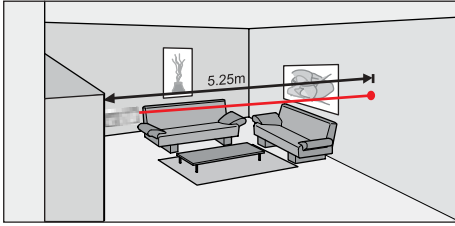
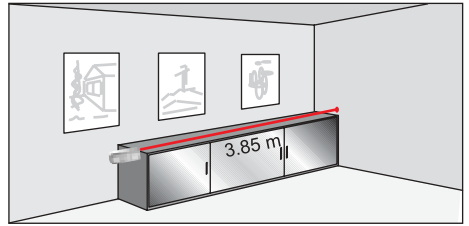
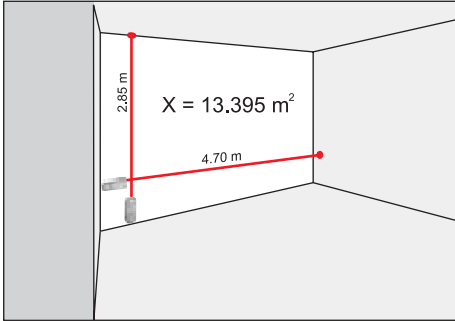
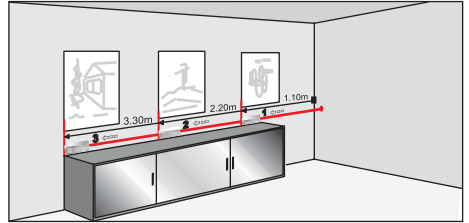
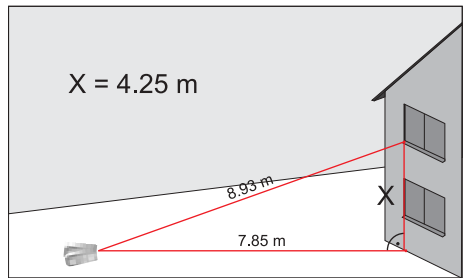
G**H****I****J****K**

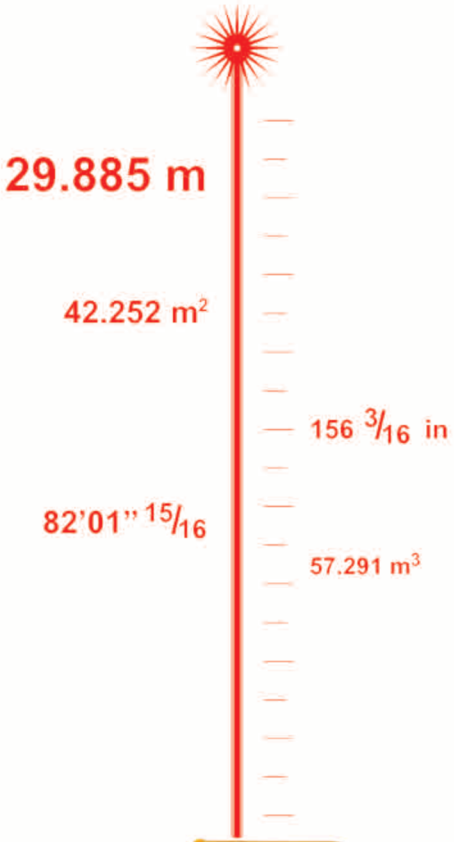

Prexiso AG
 Europastrasse 27
 CH-8152 Glattbrugg
 Internet: www.prexiso.com

PREXISO
 LASER DISTANCE METER